

LEISTER

Hilltop
40 Years' Experience

English

TRIAC AT

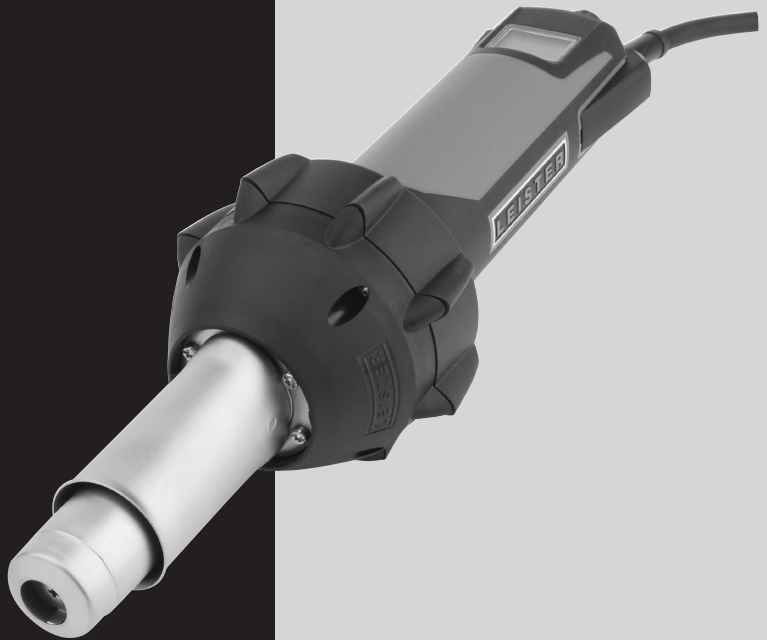

Hilltop Products Ltd -
www.hilltop-products.co.uk - Tel:
+44 1942 723101 - Email:
sales@hilltop-products.co.uk

Contents

| | |
|--|-----------|
| 1. Application | 3 |
| 1.1 Power supply | 3 |
| 1.2 Protective clothing | 3 |
| 1.3 Intended use | 3 |
| 1.4 Unintended use | 3 |
| 1.5 Safety Instructions | 3 |
| 2. Functions | 4 |
| 3. Technical data | 4 |
| 4. Your TRIAC AT | 5 |
| 4.1 Overview of device parts | 5 |
| 4.2 Control knob (e-Drive) | 5 |
| 4.3 Display | 6 |
| 5. Commissioning | 6 |
| 5.1 Connect the device to the power supply (standby) | 6 |
| 5.2 Turning the device on (operation) | 6 |
| 5.2.1 Setting the temperature | 7 |
| 5.2.2 Setting the air volume | 7 |
| 5.2.3 Checking the supply voltage | 7 |
| 5.2.4 Locking / unlocking the controls (e-Drive) | 7 |
| 6. Decommissioning | 8 |
| 6.1 Turning the device off using the cool down function | 8 |
| 6.1.1 Cancel turn down (revert to operation) | 8 |
| 6.1.2 Enforced power down (continue to standby) | 8 |
| 6.2 Turning the device off without the cool down function (directly into standby mode) | 8 |
| 6.3 Disconnecting the device from the power supply | 8 |
| 7. Configuration menu | 9 |
| 7.1 Accessing the menu | 9 |
| 7.2 Menu navigation | 9 |
| 7.2.1 Defining the unit of temperature | 9 |
| 7.2.2 Defining the working range | 9 |
| 7.2.3 Defining eco mode | 9 |
| 7.3 Exiting the menu | 10 |
| 7.4 Display of a changed basic configuration | 10 |
| 7.5 Resetting to the basic configuration (Reset) | 10 |
| 8. Warnings | 11 |
| 9. Errors and error codes | 11 |
| 10. Maintenance and repair | 12 |
| 10.1 Cleaning the air filter | 12 |
| 10.2 Changing the heating element and mica tube | 12 |
| 11. Disposal | 12 |
| 12. Other applicable documents | 12 |
| 13. Declaration of Conformity | 13 |

Congratulations on your TRIAC AT purchase.

You have chosen a first-class hot-air blower.

The TRIAC AT was developed and produced in accordance with the latest state-of-the-art technology in the plastics-processing industry.



We recommend that you always keep the instruction manual with the device.

TRIAC AT

Hot-air blower

You can find more information about the TRIAC AT online at www.leister.com

1. Application

1.1 Power supply

Any **extension cables** must be approved for usage site and be marked accordingly. Comply with the necessary minimum conductor cross-section for extension cables, as required.

| |
|--|
| 230V~ up to 10m 2 x 1.5 mm ² 120V~ up to 10m 2 x 16AWG |
|--|

When using on-site **generators as a power supply**, please ensure that the generators are equipped with residual-current circuit breakers. For the nominal output of the generators, the formula “2 × nominal output of the hot-air blower” applies.

1.2 Protective clothing

We recommend that persons should wear suitable protective clothing (gloves, apron or similar) when using the device.

1.3 Intended use

This hot-air blower is suitable for welding, shrinking and shaping thermoplastics, as well as for heating up and drying thermoplastics.





1.4 Unintended use

Any other use of the TRIAC AT or any use beyond the type of use described is deemed improper use.

1.5 Safety Instructions





The safety instructions for device can be found in the “Safety Instructions – Hand Tools” section in the document provided. You can also find this document in the operating instructions on our website.

2. Functions













| | | |
|---------------------------------|--|---|
| Temperature | Input in increments of 5°C / 10°F Cold air setting (heating OFF). |  7 [5.2.1] |
| Readiness | Display of the temperature difference from the setpoint. |  6 [5.2] |
| Air volume | Selection of five increments. |  7 [5.2.2] |
| Limitation of the working range | The range is defined by the temperature and air volume. This can be used to prevent errors in the application. |  7 [5.2.1] |
| e-Drive lock | Lock the controls for protection against unauthorized inputs. |  7 [5.2.4] |

Eco mode is an automatic reduction in power that can be activated and configured.

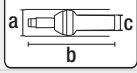
| | | |
|----------|---|---|
| Eco mode | If the device has not been moved during the configured rest period (d), the output is reduced (temperature will maintain). Optionally, the device activates the cool down function and switches into standby mode when the configured idle time (t) in eco mode is exceeded. |  8 [6.1] |
|----------|---|---|

| | | |
|--------------------------------|---|---|
| Cool down | Cool down procedure with automatic standby mode activates when the temperature of the device is close to the ambient temperature. |  8 [6.1] |
| Protection against re-starting | Protection against restarting when power is restored after an interruption. | |
| Supply voltage | Displays the actual supply voltage. |  7 [5.2.3] |
| Voltage monitoring | Warning in the event of undervoltage. |  11 [8] |
| Monitoring the heating element | Detection of heating element failure. |  11 [9] |

3. Technical data

| | | | | | |
|---|------------------|---|-------|------|-------|
|  | V~ | 100 | 120 | 220 | 230 |
| | Hz | 50/60 | 50/60 | 60 | 50/60 |
| | W | 1500 | 1600 | 1600 | 1600 |
|  | °C | 40 – 620 | | | |
| | °F | 100 – 1150 | | | |
|  | l/min (20°C) | 160 - 240 | | | |
| | cfm (68° F) | 5.7 - 8.5 | | | |
|  | dB (A) | 67 (K = 3) | | | |
|  | m/s ² | < 2.5 (K = 1.5) | | | |
|  | kg | 1.02 | | | |
| | lbs | 2.2 | | | |
|  | a) ø mm / inch | 90 / 3.5 | | | |
| | b) mm / inch | 338 / 13.3 | | | |
| | c) ø mm / inch | 56 / 2.2 | | | |
| | |      | | | |

We reserve the right to make any technical changes.

4. Your TRIAC AT

4.1 Overview of device parts

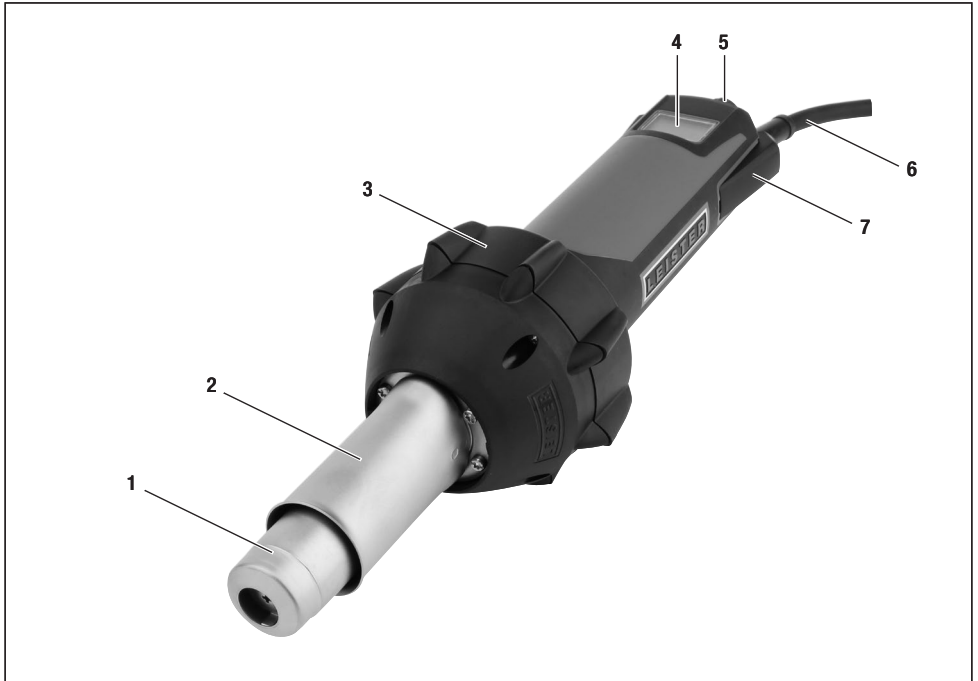

- | | |
|--|---------------------------|
| 1. Heating element tube | 5. Control knob (e-Drive) |
| 2. Protective tube | 6. Power supply cord |
| 3. Soft coating for non-slip placement | 7. Air filter |
| 4. Display | |

4.2 Control knob (e-Drive)

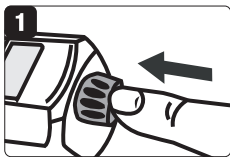

long press (>1s)

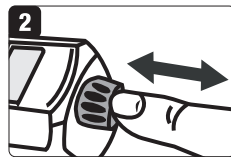

short press (<1s)

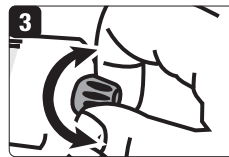

turn

4.3 Display

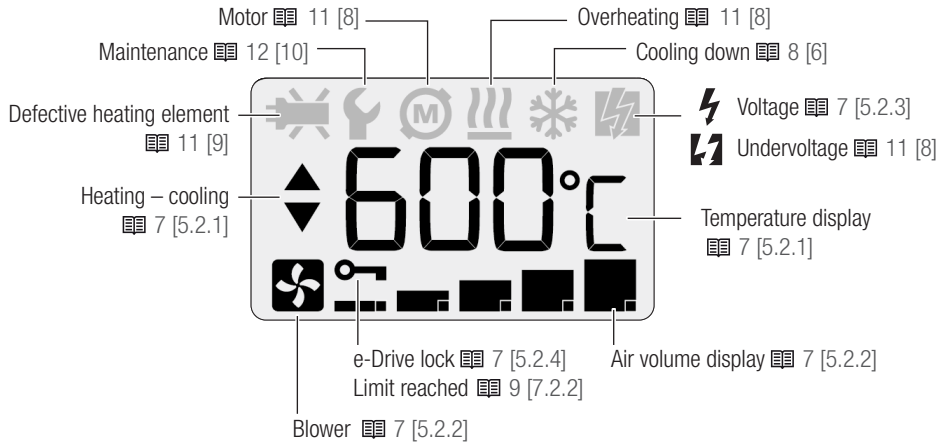

5. Commissioning

5.1 Connect the device to the power supply (standby)



Hazardous voltage: Risk of injury or death if the cable or power plug is damaged. Prior to commissioning, check the power supply cord and the power plug together with the extension cable for electrical and mechanical damage.



The **nominal voltage** specified on the device must match the local supply voltage.

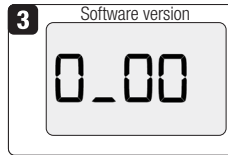
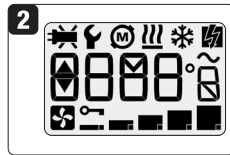
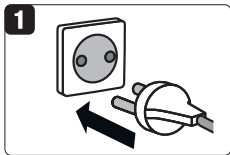

5.2 Turning the device on (operation)



Fire hazard and burn hazard

Do not touch the heating element tube and/or nozzle when they are hot, since they pose potential threat of injuries. Do not point the hot air flow at people or animals.

A long press on the e-Drive will turn the device on. The device heats up until it reaches the setpoint from the last time it was used. Once there is no longer a difference in temperature (flashing arrow), the device is ready to use.

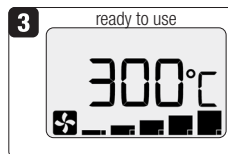
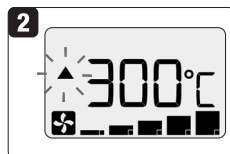

5.2.1 Setting the temperature

The setpoint for the temperature can be set directly by turning the e-Drive. Once there is no longer a difference in temperature (flashing arrow), the device is ready to use.



5.2.2 Setting the air volume

After a short press on the e-Drive, the air volume display starts to flash. The setpoint for the air volume can now be changed by turning the e-Drive. If no further input is performed for four seconds, the device automatically exits this input mode.

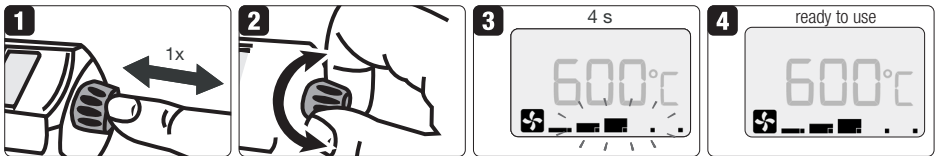

5.2.3 Checking the supply voltage

After two short presses on the e-Drive, the actual supply voltage is displayed. After four seconds, the device automatically exits this display mode.

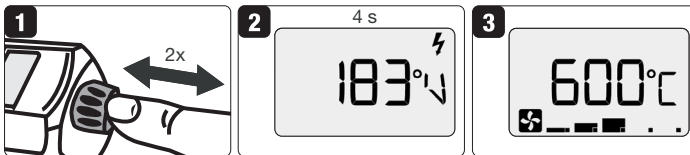

5.2.4 Locking / unlocking the controls (e-Drive)

In order to prevent changes to the settings by accidentally touching the e-Drive, the e-Drive dial can be locked. Depress the control knob and turn it at least 90° (at the same time) clockwise and counter-clockwise to lock or unlock the e-Drive.

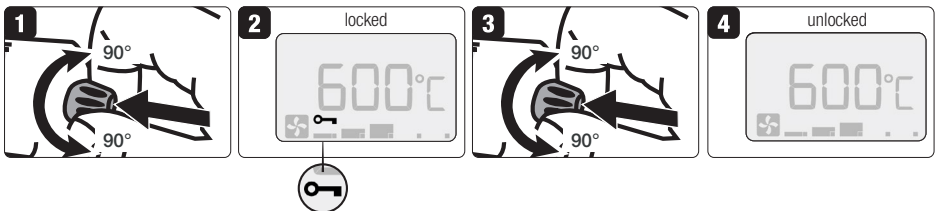

6. Decommissioning

6.1 Turning the device off using the cool down function

A long press on the e-Drive, while the device is in operation, will start the cool down function.

The device turns itself off automatically when the temperature of the device is close to the ambient temperature.

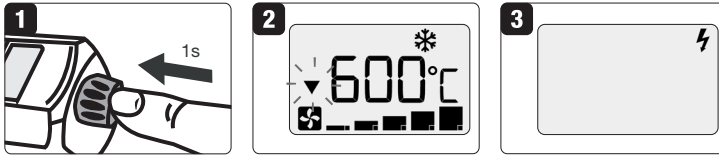

6.1.1 Cancel turn down (revert to operation)

After a short press on the e-Drive while the device is cooling down, the device reverts to operation.

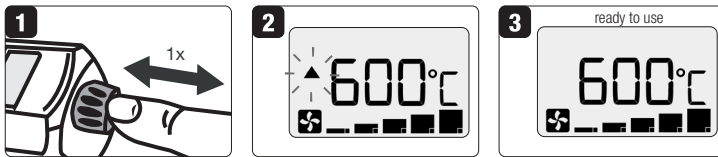

6.1.2 Enforced power down (continue to standby)

Fire hazard and burn hazard



Do not touch the heating element tube and nozzle when they are hot, since they pose potential threat of injuries. After use, allow the device to cool down.

After a very long press on the e-Drive, while the device is cooling down, the device switches into standby mode (cancels the cool down function). Caution, the device may still be very hot.

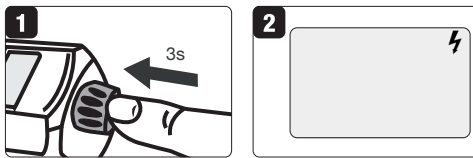

6.2 Turning the device off without the cool down function (directly into standby mode)

Fire hazard and burn hazard



Do not touch the heating element tube and nozzle when they are hot, since they pose potential threat of injuries. After use, allow the device to cool down.

After a very long press on the e-Drive whilst the device is in operation, the device switches into standby mode (after one second it starts the cool down function and performs it for two seconds). Caution, the device may still be very hot.

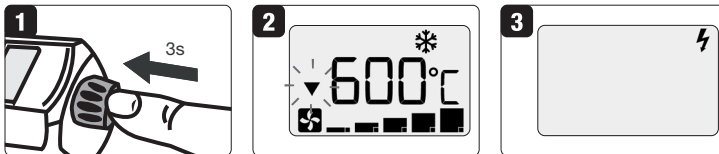

6.3 Disconnecting the device from the power supply

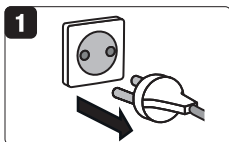

7. Configuration menu

7.1 Accessing the menu

After four short presses on the e-Drive, the menu will pop up.

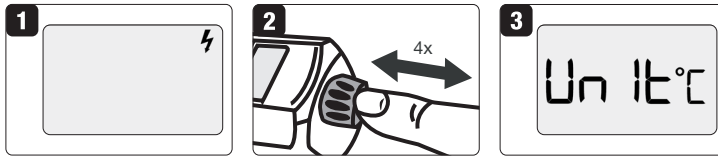

7.2 Menu navigation

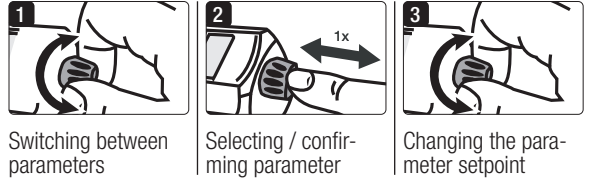

7.2.1 Defining the unit of temperature

Unit of temperature

°C = Celsius
°F = Fahrenheit

7.2.2 Defining the working range

Lowest available temperature
OFF → 620°C

Highest available temperature
620°C → OFF

Lowest available blower step



Highest available blower step



7.2.3 Defining eco mode

Eco mode:

0 = OFF
1 = ON (configurator)

Rest period (d) before the output reduction (eco mode) 10" → 60" in 5-second (") steps

Idle time (t) in eco mode before the device automatically cools down and switches itself off.

-- = OFF (unlimited idle time in eco mode)
5' → 60' in 5-minute (') steps

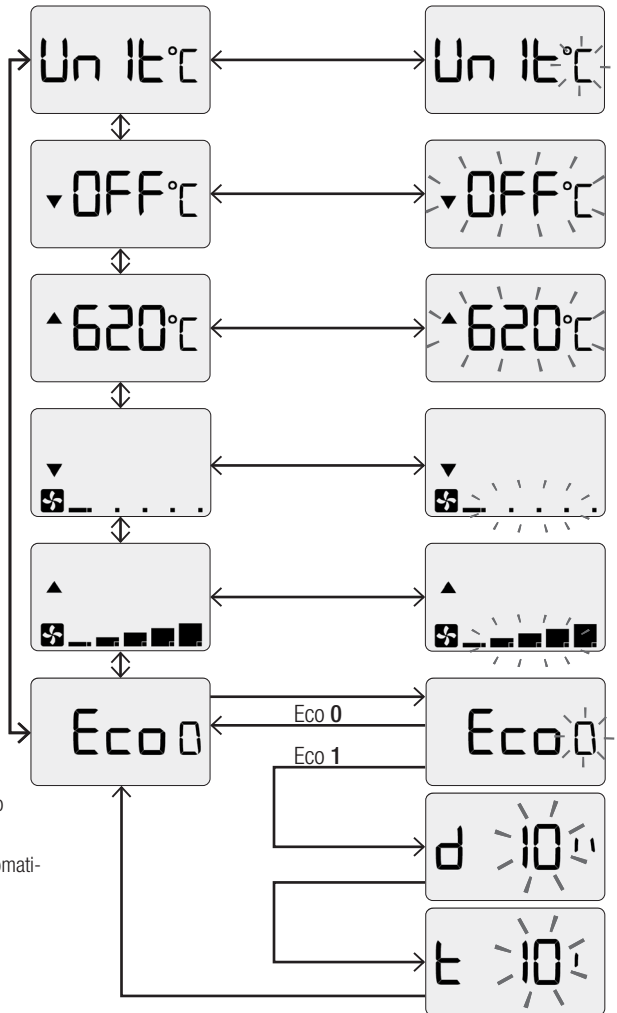

7.3 Exiting the menu

After a long press on the e-Drive, the menu will close.



7.4 Display of a changed basic configuration

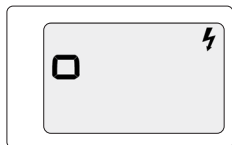

Device with a changed basic configuration

7.5 Resetting to the basic configuration (Reset)

Keep the e-Drive depressed, connect the device to the rated voltage and wait until RESET appears. The reset will be performed once the e-Drive is released.

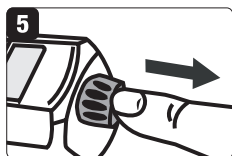
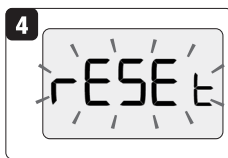
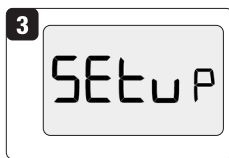
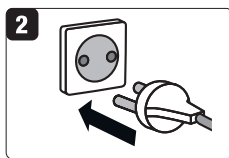
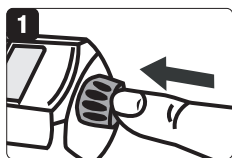

Device with a basic configuration

8. Warnings

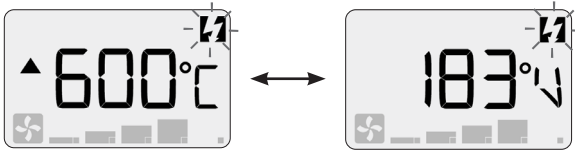

Undervoltage → check the supply voltage  7 [5.2.3]

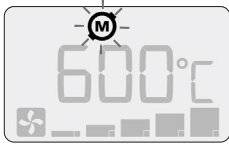

About to reach the max. operating hours for the carbon brushes → Maintenance recommended. Contact your Leister service center.

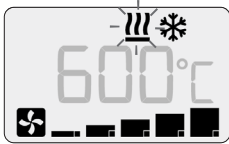

Device overheated (automatic cool down → check the air flow, e.g. clean the air filter  12 [10.2]), check the nozzle etc.

9. Errors and error codes



Defective heating element → Replace  12 [10.1]



Withdraw the power plug → start the device again. If the error recurs, contact your Leister service center.

10. Maintenance and repair

With the exception of the following instructions, repairs may be performed exclusively by Leister-service centers.

10.1 Cleaning the air filter

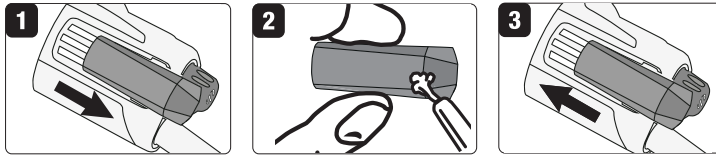

10.2 Changing the heating element and mica tube



Hazardous voltage: risk of injury or death when opening the device due to exposed live components and terminals. Withdraw the mains plug from the socket before opening the device.

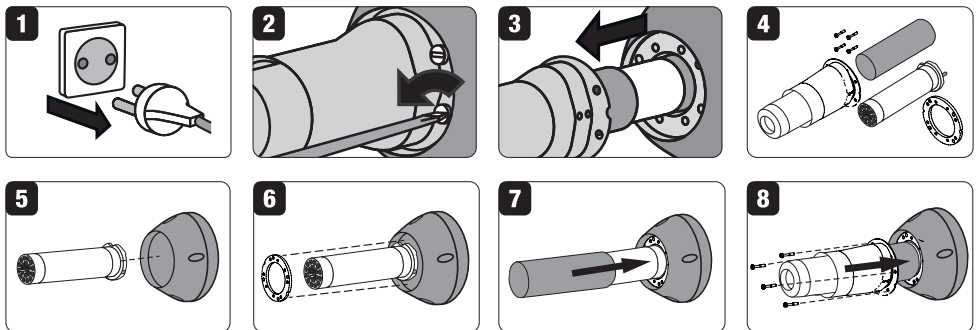

11. Disposal



Electrical equipment, accessories, and packaging should be recycled in an environmentally friendly way. When you are disposing our products, please observe the national and local regulations. **For EU countries:** Do not dispose electrical equipment with household refuse.

12. Other applicable documents

- Safety Instructions – Hand Tools (item number: 129.099)



EC declaration of conformity

(in terms of the EC machinery directive 2006/42; Appendix II A)

| | |
|-----------------------------|---|
| Designation | Hot Air Tool |
| Type | TRIAC AT |
| EU directives | 2006/42/EC (Machinery Directive) 2014/30/EU (EMC Directive) 2011/65/EU (RoHS Directive) |
| Harmonised standards | EN ISO 12100:2010 EN 55014-1:2006 + A1:2009 + A2:2011 EN 55014-2:2015 EN 61000-6-2:2005 EN 61000-3-2:2014 EN 61000-3-3:2013 EN 62233:2008 EN 60335-1:2012 + A11:2014 + A13:2017 EN 60335-2-45:2002 + A1:2008 + A2:2012 EN 50581:2012 |



Warranty

- The guarantee or warranty rights granted for this device by the direct distribution partner/salesperson apply from the date of purchase. In the event of a guarantee or warranty claim (verification by invoice or delivery note), manufacturing or processing errors will be rectified by the sales partner through replacement delivery or repair. Heating elements are excluded from warranty obligations or guarantees.
- Other guarantee or warranty claims are excluded within the framework of mandatory law.
- Damage resulting from natural wear, overload, or improper handling is excluded from the warranty.
- No guarantee or warranty claims exist for devices that have been converted or modified by the purchaser.